

Potclays Firemaster 6® Kiln Controller

User's Guide

**Potclays Ltd
&
Orton Ceramic Foundation**

Potclays Ltd
Brickkiln Lane
Etruria
Stoke-on-Trent
ST4 7BP

Orton Ceramic Foundation
6991 Old 3C Highway
Westerville, Ohio 43082-9026
Telephone: (614) 895-2663
Fax: (614) 895-5610
www.ortonceramic.com

January 2012

TABLE OF CONTENTS

INTRODUCTION..... 3

PRECAUTIONS..... 3

FEATURES 3

TEST FIRING WITH WITNESS CONES 5

CONE-FIRE – HOW IT WORKS..... 5

KEYPAD OVERVIEW 6

 DISPLAY LIGHTS..... 7

 STARTING A FIRING..... 7

 ENDING A FIRING 7

 ENTERING VALUES 7

 THRESHOLD ALARM..... 8

 PROGRAM REVIEW..... 8

 POWER CONSUMPTION..... 8

 DELAY START 8

 STATUS 8

 BACK 8

PROGRAMMING FOR CONE-FIRE..... 9

 CONE TABLE..... 9

 CONE FIRE EXAMPLE 10

USER PROGRAMS..... 11

 TEMPERATURE UNITS 11

 USER PROGRAM HEATING/COOLING RATES..... 11

 MAXIMUM RAMP RATE FOR USER PROGRAMS..... 12

 USER PROGRAM TARGET TEMPERATURES..... 12

 USER PROGRAM COOLING RAMPS..... 12

 CHANGING A TARGET TEMPERATURE DURING A FIRING..... 12

 USER PROGRAM HOLD TIME..... 12

 SET-POINT HOLD 13

 ADDING TIME TO A HOLD..... 13

 SHORTENING A HOLD..... 13

 USER PROGRAM VENT FAN (OPTIONAL)..... 13

 PROGRAMMING USER PROGRAMS..... 14

 SELECTING A STORED USER PROGRAM..... 14

 USER PROGRAM EXAMPLE..... 15

ALARMS 16

 THERMOCOUPLE ALARMS..... 16

 DEVIATION ALARMS 17

 POWER INTERRUPTION ALARMS 17

 DIAGNOSTIC ALARM 17

OPTIONS MENU..... 17

 FIRING SPEED - SPD 18

 CONE OFFSET - OFST 19

 THERMOCOUPLE OFFSET - TCOS..... 19

 VENT FAN - FAN 19

 TEMPERATURE DIFFERENCE - DIFF..... 19

 CHANGE TEMPERATURE UNITS – CHG-..... 20

 THERMOCOUPLE TYPE - TC..... 20

 AUXILIARY OUTPUT - AOP 20

Firemaster 6 ® Kiln Controller

RAMP RATE UNITS - RATE.....	20
ELECTRICITY COST - COST	20
KILOWATT RATING - KW.....	20
IDENTIFICATION NUMBER - ID.....	20
TEMPERATURE DEVIATION - TEDE.....	21
TOP/BOTTOM BALANCE - BAL.....	21
CENTRE ZONE ADJUSTMENT - CADJ.....	21
SAFETY TEMPERATURE - SFTY	21
THERMOCOUPLE TEMPERATURES – T123	21
ELECTRONICS TEMPERATURE - ELEC	21
PROGRAM LOCK MODE - LOCK	21
CONFIGURATION NUMBER - CFG.....	22
SOFTWARE VERSION - SOFT.....	22
TEST INPUTS AND OUTPUTS - TEST.....	22
RESET - RST	22
REFERENCE SECTION	23
APPENDIX A – LOW FIRE CONE PROGRAMS.....	23
APPENDIX B – MID FIRE CONE PROGRAMS	24
APPENDIX C – HIGH FIRE CONE PROGRAMS	25
APPENDIX D – USER PROGRAM CHARTS.....	26
APPENDIX E – CONNECTING THERMOCOUPLES.....	27
APPENDIX F – TYPICAL WIRING DIAGRAM.....	28

Introduction

This User's Guide explains the features and operation of the Model Firemaster 6® Controller.

The controller has 12 keys for programming.

The Firemaster 6 controller uses P-I-D control algorithms to tightly control kiln temperature. This eliminates temperature cycling. Cycling occurs when the controller turns the kiln on or off in a way where the actual temperature does not closely follow the desired firing schedule.

The controller stores all of the program information in memory when turned off. If power is lost during a firing, the controller remembers how far the firing has progressed and determines if it can resume the firing when power is restored.

Controller Models

There are two basic controller models in this range. These instructions are for the Firemaster 6:

Firemaster 6 Single Zone – These use a single thermocouple to control the kiln temperature

Zonemaster Multi Zone – These use 2 or 3 thermocouples to separately control sections of a kiln

Precautions

The controller is not a safety device. The controller operates relays to turn the kiln elements on and off. It is possible for relays to fail in the 'on' position. The controller cannot protect against relay failure. To prevent over firing, never leave the kiln unattended, especially at the end of a firing.

Controller accuracy and performance depends on the condition and position of the thermocouples in use.

Getting Started

Read all precautions and instructions before using your controller.

If your kiln has manual control switches for the heating elements, turn all the dials to the highest settings.

If you have a Kiln-Sitter® on your kiln, you can use a Cone 10 bar under the sensing rod to shut off power if the kiln reaches high temperatures. This bar will last many firings and can act as a backup safety device for the firing.

Features

The Firemaster 6® includes many standard features, a user-friendly keypad and robust temperature control software.

Firing Methods and Features

- **Cone-Fire** method: Select a preset program for a specific cone number from Cone 022 to Cone 12. These programs are designed specifically for ceramic firings.
- **User Program** method: Create 4 custom firing schedules with unique heating and cooling rates, target temperatures and hold times. This method can be used for ceramics, heat treating, glass fusing, enameling or jewelry applications.
- **Preheat** - Use with Cone-Fire mode to slowly dry ware and hold the kiln at 200°F (93°C) to remove moisture.
- **Speed** adjustments - Use with Cone-fire mode to speed up or slow down a firing in order to adjust for load size or thick pieces of ware.
- **Delay start** - Use with either mode to delay start the kiln up to 100 hours (99hr.59min.)
- **Set-Point** Control - User Program option to hold kiln at temperature indefinitely.
- **Full On / Full Off** - User Program option to heat kiln as fast as possible or to cool as fast as possible.
- **Add Time** – Add additional hold time to firings already in progress.
- **Back** – Correct or make changes while programming without having to start over.
- **Program edit** – User Program option to change target temperatures and hold times during the firing without having to stop and restart the controller.

Advanced Options

- **Cone Offset** - Use with Cone-Fire to adjust the firing temperature of the kiln by $\pm 11^{\circ}\text{C}$ ($\pm 20^{\circ}\text{F}$) to fine tune the controller to your kilns performance.
- **Skip** - Skip from a current ramp or hold segment to the next ramp segment
- **Alarm** - Program an alarm to sound when a specific temperature is reached.
- **Thermocouple Offset** - Adjust display temperature by as much as $\pm 25^{\circ}\text{C}$ ($\pm 45^{\circ}\text{F}$) to offset aging thermocouple(s).
- **Auxiliary Output** - Control a relay to switch on a vent fan or external alarm
- **Power Consumption** – Review the calculated cost or Kilowatt usage of the kiln firing.

Display Messages and Information

- **Cone Table** - Look up table for cone number temperatures
- **Program Review** - Review the current firing program before or during a firing.
- **Status** - Display the current status and actual heating/cooling rates of the firing.
- **Temperature Units** - Display Temperature in Fahrenheit (°F) or Centigrade (°C) Units
- **Computer Interface** - Program and monitor a kiln from a PC using *ControlMaster* software.

Test Firing with Witness Cones

A test firing will help in learning the operation and features of the controller. Follow your kiln manufacturer's instructions for setting up your kiln.

Place a set of Orton Self-Supporting Cones on the middle shelf of your kiln so that they can be seen through a kiln peephole. Use a series of cones close to the final firing temperature (see Appendix C). For example, if firing to 1945°F (Cone 04), use a Cone 03, Cone 04, and Cone 05 for the test firing.

To evaluate heat distribution, place a set of cones on each shelf during the test firing. Most kilns fire more uniformly at Cone 06 than they do below Cone 06. Provide ventilation for the kiln in accordance with the kiln manual or KilnVent® instruction manual.

After the firing, examine the fired cones. Some variation in the bending of the cones may occur, depending on how the kiln was loaded and the location of the cones.

Cone-Fire – How it works

When firing to a cone number, the controller constantly monitors the actual heating rate of the kiln. If the kiln does not fire as rapidly as programmed, the controller re-calculates and adjusts the top firing temperature to compensate for the slower firing rate. This process more accurately fires to the cone number selected. When the heating rate slows, cones deform at slightly lower temperatures. At faster heating rates, cones deform at slightly higher temperatures. This ability to recalculate and to fire to a cone value is a unique, patented feature of the Potclays/Orton Firemaster 6 controller.





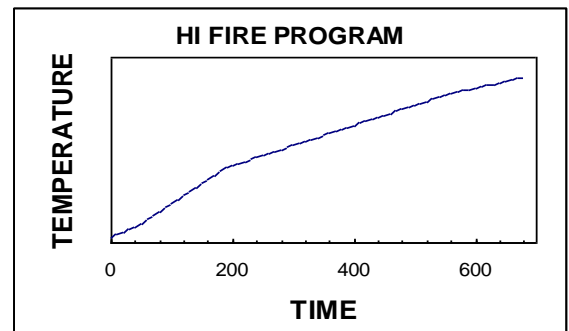
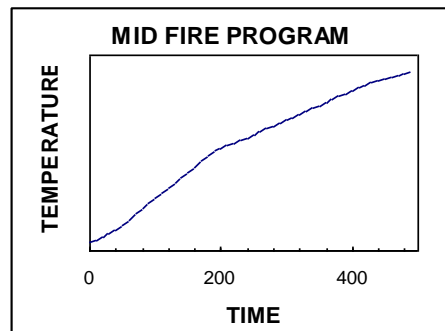
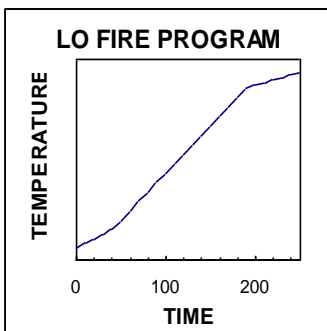







The Firemaster 6 Controller contains three preset programs for firing to a cone number – Low Fire, Mid Fire, and High Fire. Each of these programs can be adjusted to a cone temperature within the firing range. These programs are designed to fire normal loads of thin ware ceramics. When a kiln is more heavily loaded or when thick ware is fired, additional firing time is needed. Experiment to determine the best firing conditions. The preset firing programs in the controller are:

<u>Program</u>	<u>Product Fired</u>	<u>Cone Range</u>	<u>Firing Time</u>
Low Fire	Decal, Luster, China	Cones 022 – 011	3 - 5 hours
Mid Fire	Glaze, Bisque, Earthenware	Cones 010 - 01	6 - 8 hours
High Fire	Stoneware, Porcelain	Cones 1 – 12	9 - 11 hours



Keypad Overview

Numerical values for cone numbers, hold times, target temperatures and heating rates can be programmed by using the numerical keypad. Most keys have multiple functions for special features as described below.

	Use to select a Cone Fire program Acts as a scroll <u>Down</u> button to change Option settings Use to select Fast speed during Cone-fire programming
	Use to increase hold time for active firings Acts as a scroll <u>Up</u> button to change Option settings Use to select Standard speed during Cone-fire programming
	Use to program a delay start time Use to select Slow speed during Cone-fire programming
	Use to select one of the 4 customized User Programs Use to edit a User Program in progress
	Use to display current program segment during a firing Use to review the actual heating or cooling rate during a ramp segment
	Use to review the entire program before or during a firing
	Use to set a temperature for the alarm to sound
	Use to review the Kilowatt power consumption or cost of the kiln firing.
	Use to Skip to next ramp during a firing Use to look up cone temperatures before a firing
	Use during programming to enter values Use to Start the firing
	Use to access advanced controller options
	Use to back up during programming Use to Stop a firing or exit the options menu

Display Lights

The controller uses (4) numerical displays and 3 indicator lights. The 3 lights tell when the controller is turning on the relays to power the heating elements. For the Firemaster 6 single zone controller, all 3 lights turn on and off together unless the *Balance* option has been adjusted. The top light represents the top zone, the middle light represents the middle zone and the bottom light represents the bottom zone.



Two of the four decimal points on the display are also used as indicators. The decimal point on the far right is used to indicate if the controller is displaying temperature in degrees Fahrenheit (°F) or Centigrade (°C). If this decimal point is lit, the controller is set to display temperatures in °C.

The centre decimal point (between the second and third digit) lights whenever the display is showing a time value. The decimal point separates Hours (on the left) from Minutes (on the right).

When the Controller is first turned on

The controller runs a brief self-diagnostic test. The display will light up and the audible alarm sounds temporarily. In 5 seconds or less, the display will alternate between the kiln temperature and **IdLE**. **IdLE** is the mode where the controller is not actively firing the kiln or being programmed for a firing.

Starting a Firing



The display shows **STRT** for 5 seconds when the firing begins. **STRT** is the ‘Start’ message. The display will show kiln temperature throughout the firing. The temperature display will alternate with alarm messages if any alarms occur. If the controller is programmed to hold at a specific temperature, the remaining Hold Time will alternate with the temperature as well.

Ending a Firing



When the controller completes the firing, the display alternates 4 messages: **CPLT** (Firing Complete); Firing Time (**hrs.mins**); Final Firing Temperature and Current Kiln Temperature. Press any key to return to **IdLE**. If you stop the firing before completion with the **Stop** key, the display will indicate **AbRT** (abort) in place of **CPLT**. Press **Stop** again to return to **IdLE**.

Entering values



Whenever a change is made from the keypad, you must press the **Enter/Start** key to load the changes. If the key is not pressed, the controller will simply wait for your next selection. Pressing the **Enter/Start** key will advance you to the next option if you are setting up a program or changing settings.

*Note: If you are programming the controller and no keys are pressed for 1 minute, the controller will return to the **IdLE** mode.*

Threshold Alarm



To sound an audible alarm when the controller reaches a temperature, press the **#7/Alarm** key. **ALAR** shows in the display alternating with the alarm temperature. You can use the numerical keypad to enter a new alarm temperature or press **Enter** to keep the existing value. Setting the value to zero disables the alarm feature. When the kiln reaches the alarm temperature, the display will indicate **ALAR** and the buzzer will sound. Silence the alarm by pressing any key except **Stop**. Pressing **Stop** ends the firing.

Use the alarm function in Cone-fire mode or User Program mode. You can program the Alarm before you start the firing or during the firing.

Program Review



To review the current program in the controller memory before or during a firing, press the **#6/ProgReview** key. The entire program will automatically scroll through the display and then return to normal operation. Delay time and Preheat time are included in the review.

Power Consumption



To review the current power consumption during or after the kiln firing, press the **#8/Cost KWHR** key. The display will show the calculated electric usage for the firing if the option **KW** is programmed with a known wattage rating for the kiln. In addition, the display will show a calculated firing cost if the **COST** option is programmed with a known price for KWHR usage. *Note: These calculations are estimates and are dependent on the accuracy of the values set by the operator.*

Delay Start



To program the controller to begin a firing at a later time, press the **#3/Delay** key. **dELA** shows in the display. Using the numeric keypad, enter a time delay in Hours.Minutes format and press **Enter**. Delay must be programmed before the firing is started. Once the firing is started, the remaining delay time will count down on the display.

Note: you can bypass the Delay time once the delay period has started by pressing the **Enter** key.

Status



To review the current status of the controller during a firing, press the **#5/Status** key. The current ramp segment is displayed. If the current status is a heating or cooling ramp, the display will also show the actual ramping rate. (See the **RATE** option for more information on how the actual ramp rate display can be modified) The controller returns to normal operation after 5 seconds.

Back



To back-up during programming press the **Back/Stop** key. This will return you to the previous entry. The 'Back' feature can be used anytime during programming to make corrections. This prevents the need to start over when programming a User Program or Cone-fire program.

Repeating a firing

To Repeat a firing without making changes to the program, simply press **Start** when the controller is displaying **IdLE**. Use the Program Review feature to verify that the program you want is loaded into memory.

Programming for Cone-Fire



During programming, default values may appear in the display. If the controller was previously programmed, the last settings will appear.

1. Press The **#1/ConeFire** key. **CONE** shows in display alternating with the last Cone selection value.
2. Using the numeric keypad, select the desired Cone number. For Example: you would press the **#0** key and the **#6** key for a Cone 06 firing. Then press **Enter**.
3. **SPd** shows in the display indicating the Speed setting - Press the **#1** key to select 'Fast', **#2** key to select 'Standard' or the **#3** key to select 'Slow'. Then press **Enter**.
4. **PRHT** shows in the display indicating the optional preheat time. Preheat will heat the kiln at the rate of 60°F(33°C)/hr up to 200°F(93°C), **PRHT** will be alternating with a Time value. Using the numeric keypad, enter a time for the kiln to hold at 200°F. Time is entered in (Hours.Minutes). If no preheat is needed, program zero hours and zero minutes (00.00). Then press **Enter**.

*After the kiln firing has started and the Preheat temperature is reached, the Cone Fire program will begin automatically once the Preheat hold time has expired. You can Skip out of the Preheat ramp or hold period at any time by pressing the **#9/Skip** key and **Enter**.*

5. **HOLD** shows in the display indicating the optional Hold time at the end of the firing, **HOLD** will be alternating with a Time value. Using the numeric keypad, select a time for the kiln to hold at the top cone temperature. Enter time as (Hours.Minutes). If no Hold is needed, program zero hours and zero minutes (00.00). Then press **Enter**.
6. **COOL** shows in the display indicating the optional Cooling ramp at the end of the firing, **COOL** will be alternating with a rate value. Using the numeric keypad, Enter a cooling rate for the kiln to cool to 392°F(200°C). The maximum cooling rate is limited to 180°F(100°C)/hour. If no controlled cooling is needed, program the rate value as zero. Then press **Enter**.

*The controller will return to **IdLE**. The programmed firing schedule is automatically stored and ready to begin the firing. To verify the program, you can press the **#6/Review** key at any time.*

7. If no advanced features are desired - Press **Enter/Start** to begin the firing

Cone Table



This feature displays the firing temperature for a Cone number. Press **#9/ConeTable** while the controller is **Idle** or during a Cone firing. Using the numeric keypad, enter a Cone number and press **Enter** to display the target temperature for self-supporting cones fired at the rate of 108°F (60°C) per hour during the final 200C of the firing.















Cone Fire Advanced Options

There are two Advanced Options available for Cone Fire programs only. These are *Cone Offset* and the *Speed* adjustment. For information on these options, see the Options Section.

Cone Fire Example

To fire to Cone 06, Fast firing speed (20% faster), 30 minute Preheat hold, 15 minute hold at cone temperature, No controlled cooling

Follow these steps: starting with the controller displaying **IdLE**

<u>Press</u>	<u>Display Shows</u>
 CONE
  06
 SPd
 FAST
 PRHT
  00.30
 HOLd
  00.15
 COOL
 00.00
 IdLE
 STRT

To stop the kiln anytime during the firing, press **Stop**. The controller display will indicate **ABRT** (Abort). Press **Stop** again to return to **IdLE**

User Programs

Four User Programs are available. The User Program mode allows you to customize your firing schedule and specify how fast the kiln heats or cools to any temperature. User Program #1 allows 20 ramps. User Programs # 2, 3 and 4 each have 10 ramps. Each ramp consists of a heating rate, a target temperature and a hold time.



Press the **#4/UserProg** key to begin programming. The message **USER** appears in the display. Use the numeric keypad to select which program you wish to create or modify. You must select 1,2,3 or 4. Then press **Enter**.

Temperature Units

If your controller is configured to display temperature values in °F, heating rates will be programmed as Degrees Fahrenheit per hour and target temperatures will be programmed as Degrees Fahrenheit. If your controller is configured to display temperature values in °C, heating rates will be programmed as Degrees Centigrade per hour and target temperatures will be programmed as Degrees Centigrade. To change the temperature units, see the *CHG*- option.

User Program Heating/Cooling Rates

Rate is the speed of the firing. Rate is programmed as Degrees per Hour if the RATE option is set to HOUR. Some calculations may be required to determine your desired heating rate.

Example; if you know that you want to heat the kiln from room temperature (75°F) to 212°F over a 2 hour period, First determine the amount of temperature rise:

$$212 - 75 = 137 \text{ degrees}$$

Then divide the amount of temperature rise (or drop) by the number of hours you would like it to take to get there.

$$137 / 2 = 68.5 \text{ degrees per hour}$$

Round the calculated rate to the nearest whole number and your heating rate would be 69 degrees/hour.

If you prefer to program heating and cooling rates in 'degrees per minute', adjust the RATE option in the options menu to MIN.

If you prefer to program heating and cooling rates in 'Hours and Minutes', adjust the RATE option in the option menu to TIME.

RA is the controller display for rate. Each ramp rate will have its own number. The rate for the first ramp will be displayed as **RA 1**, the rate for the second ramp as **RA 2** and so on.

Maximum Ramp Rate for User Programs

When the Ramp Rate is set to **9999** degrees per hour or **99.99** degrees per minute or **00.00** Time, the controller will interpret this as full power for a heating ramp. This will allow the kiln to heat as fast as possible to the target temperature without rate control. If the ramp is a cooling, the controller will interpret the same values as no power and allow the kiln to cool as fast as possible without rate control.

a Program Review will show the message **FULL** to indicate the uncontrolled rate. Deviation alarms will not be active during the heating/cooling ramp.

Caution: Overshoot in temperature may occur when a kiln is heating at full power, especially at lower temperatures.

User Program Target Temperatures

Each ramp requires you to program the desired target temperature.

F or **C** is the controller display for target temperature. Like rate, each temperature will have its own number. The temperature for the first ramp will be displayed as **F 1** or **C 1**, the temperature for the second ramp as **F 2** or **C 2** and so on.

Caution: Do not program target temperatures that exceed the temperature rating for your kiln. The maximum programmable value for target temperatures can be viewed in the *SFTY* option.

User Program Cooling Ramps

Cooling ramps are programmed the same as heating ramps. You must program the Rate for the cooling and the target temperature. The criteria for a cooling ramp is the target temperature must be lower than the preceding target temperature.

If you program a target temperature at the end of the firing that is below your room temperature, the controller will never be able to complete the firing. This will result in a **FTL** alarm. To avoid this alarm, manually stop the firing by pressing the **Stop** key or program a higher end temperature.

Changing a Target Temperature During a Firing

If the kiln is firing and you need to modify the current ramp target temperature (or hold time), Press the **#4/UserProg** key. The controller will display the current target temperature and setting. Use the numeric keypad to change the temperature value and press **Enter**. The controller will next display the current ramp hold time and setting. This too can be modified if necessary. Press **Enter** again to exit the editing mode.

User Program Hold Time

Hold time refers to the amount of time you want the kiln to remain at the target temperature. Hold Time is often referred to as Soak or Dwell Time. Each ramp allows the option of programming a hold time. Hold time is programmed in Hours and Minutes. The decimal point light in the centre of the controller display separates hours from minutes. The two digits to the left of the decimal point indicate hours while the right side indicates minutes.

Example; A 1 hour hold time should be programmed as **01.00**
 or A 30 minute hold time would be **00.30**

During a Hold time, the controller will count-down the remaining time of the Hold on the display.

Hd is the controller display for hold time. Each Hold will have its own number. The hold time for the first ramp will be displayed as **Hd 1**, the hold time for the second ramp as **Hd 2** and so on.

Set-Point Hold

You can program the controller to hold at a temperature indefinitely by programming a Hold Time of **99.59**. The controller will hold the kiln temperature until the **Stop** key is pressed.

Adding Time to a Hold



If the kiln is firing and you need to add time to the current ramp hold time, press the **#2/AddTime** key. 5 minutes will be added to the hold time each time the key is pressed. If the firing is in the first ramp, you can only edit the first ramp hold time. To edit the second ramp hold time, wait until the firing has progressed into the second ramp.

Shortening a Hold



To end a hold before the time has expired, use the Skip Step function to advance to the next ramp. Press the **#9/Skip** key to view the next ramp and press **Enter**.

User Program Vent Fan (Optional)

If your controller has been configured to control an auxiliary vent fan, each ramp will allow the fan to be turned on or off during the specified ramp. Refer to the Options section for additional details on the Auxiliary Output and Fan options.

FN is the controller display for vent fan. Each ramp will have its own fan setting. The fan setting for the first ramp will be displayed as **FN 1**, the fan setting for the second ramp as **FN 2** and so on.

To set the fan to **On**, press **#1/Conefire** or to set the fan to **OFF** press **#2/AddTime** key.

Programming User Programs



During programming, default values may appear in the display. If the controller was previously programmed, the last settings will appear.

1. Press the **#4/UserProg** key. **USER** shows in display.
2. Using the numeric keypad, select the desired user program number; 1, 2, 3 or 4. *For Example:* you would press the #1 key to enter a program or to modify the existing program stored in the User Program #1 location. Then press **Enter**
3. **RA 1** shows in the display indicating the rate value for the first ramp. Use the numeric keypad to enter the desired heating rate. Then press **Enter**
4. **°F 1** or **°C 1** shows in the display indicating the target temperature for the first ramp. Use the numeric keypad to enter the desired temperature. Then press **Enter**
5. **Hd 1** shows in the display indicating the Hold time for the first ramp. Use the numeric keypad to enter the desired time for the kiln to hold at the first target temperature. Time is entered as (Hours.Minutes). Then press **Enter**
6. **FN 1** shows in the display (if available). Use the **#1 or #2** key to select a fan setting; either **OFF** or **ON** for the first ramp. Then press **Enter**. The Fan option will not appear unless the auxiliary output option for the controller has been configured.
7. Repeat steps 3 through 6 to program additional ramp rates, temperatures and hold times. After you have programmed your final ramp, the controller should be displaying the next available **RA** number. If the value for the next available ramp rate is set to zero, press **Enter**. The controller will automatically exit the programming mode.

Note: If the user program that you are working with was previously programmed, the values that have been stored in memory will appear for all the ramp settings. Whenever you enter a zero value for a rate (**RA #**), all settings beyond that point will be erased. This feature can be used to erase an entire user program by entering a zero rate at **RA 1**.

8. When the controller has returned to **IdLE**, press **Enter/Start** to start the firing.

Selecting a Stored User Program

To select a stored User Program without making any changes to the ramps.

1. Press **#4/UserProg** key. **USER** will show in display.
2. Using the numeric keypad, select the desired User Program number; **1, 2, 3** or **4**.
3. Press the **Back/Stop** key to exit programming mode.
4. When the controller has returned to **IdLE**, press **Enter/Start** to start the firing.

User Program Example

Use program #1
 To fire to 1830°F at 300°F/hour
 15-minute hold at temperature
 Cool down to 200°F at 500°F/hour
 Shut off.

Follow these steps: starting with the controller at **IdLE**

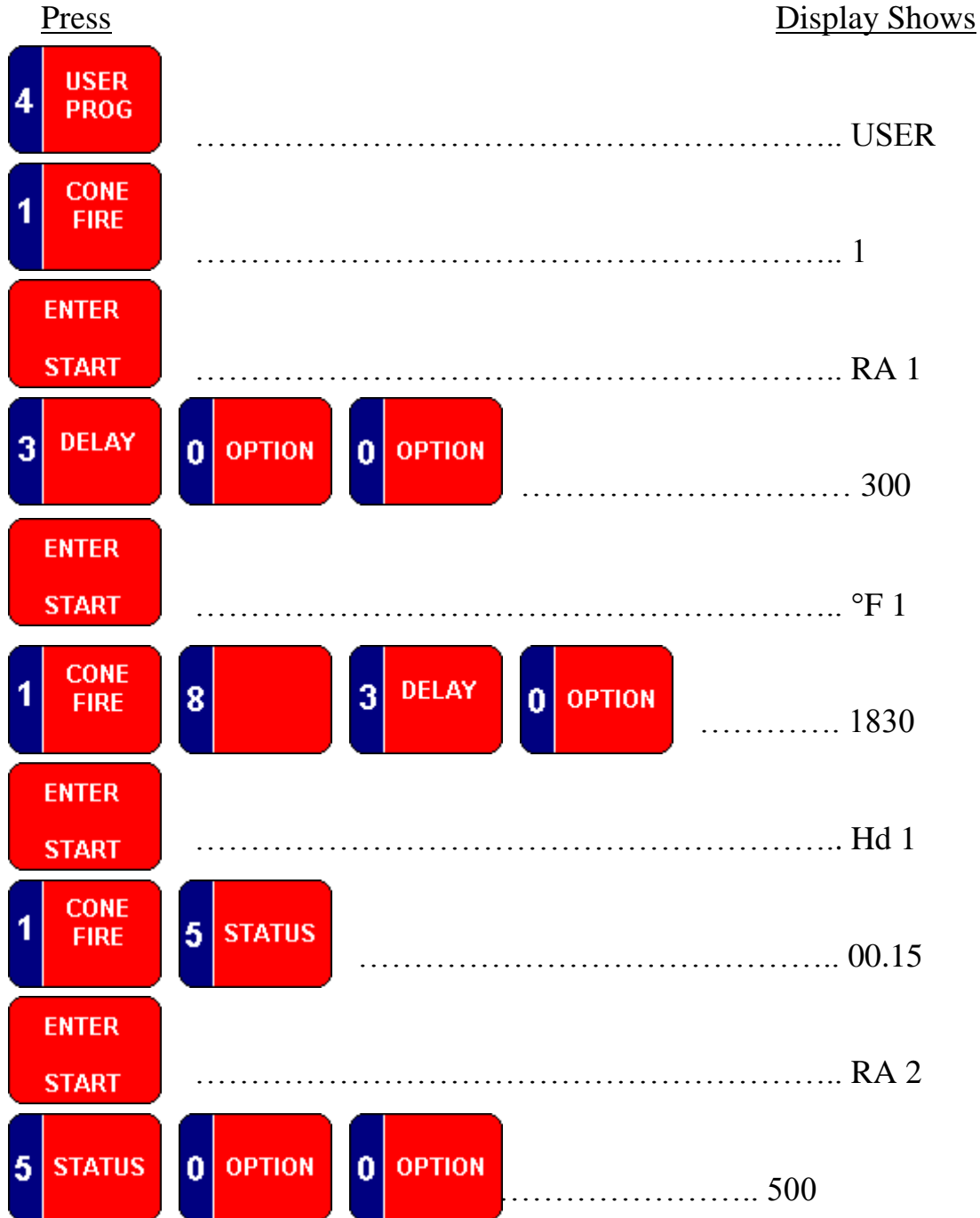

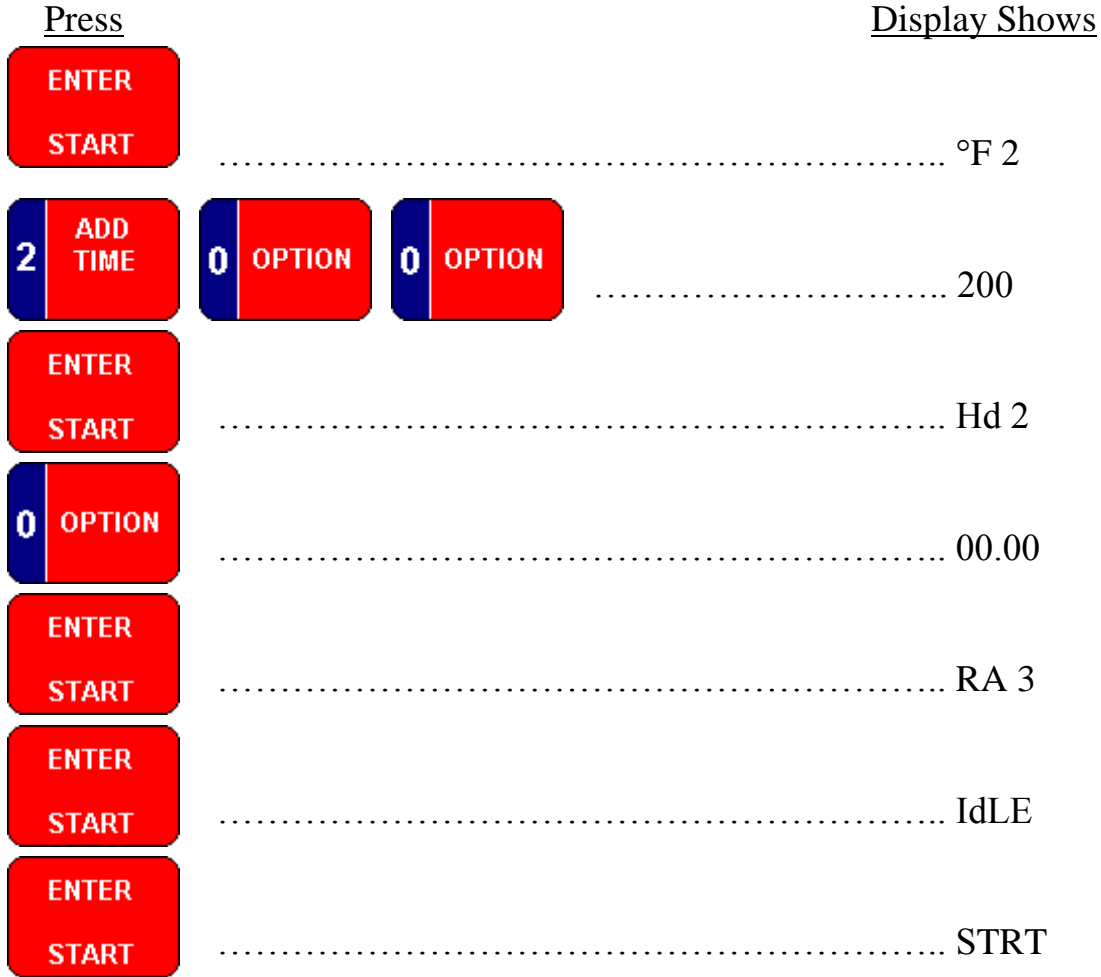

To stop the kiln anytime during the firing, press **Stop**. The controller display will indicate **AbRT** (Abort). Press **Stop** again to return to **IdLE**

Alarms

Alarms are used to notify the operator of problems with the kiln performance or controller performance. Some alarms will terminate the kiln firing while others allow the firing to continue with the alarm condition on the display. Some alarms have no affect on the outcome of the kiln firing.

Thermocouple Alarms

----	Thermocouple not detected during power up.
FAIL	Thermocouple failed during a firing, firing stopped
TC 2	Thermocouple failed while controller Idle
TCR	Thermocouple polarity reversed , firing stopped
TCL	Thermocouple temperature is lagging, firing stopped

Deviation Alarms

See *TEdE* option to adjust Deviation

FTH	Fail to Heat - kiln is heating too slow, firing continues
FTC	Fail to Cool - kiln is cooling too slow, firing continues
FTL	Firing too Long – kiln temperature has stalled, firing stopped
LTdE	Low Temp Deviation - kiln is losing temperature, firing continues
HTdE	High Temp Deviation - kiln is overheating, firing stopped

Power Interruption Alarms

PF	Power failed and firing was resumed
PF 1	Power failed and firing was stopped because cooling ramp ended
PF 2	Power failed and firing was stopped because temperature was below 212°F
PF 3	Power failed and firing was stopped because temperature dropped in the last ramp by 72°F

Diagnostic Alarm

bAdP	Invalid User Program
ETH	Electronics too Hot – controller temperature above 80°C, firing stopped

Options Menu



Advanced settings and features are available through the Options menu. Press the **#0/Option** Key to advance through the options menu. During a firing, not all options can be changed. To exit Options, press the **Stop** key or wait 1 minute without pressing any key.

To view an Option setting, press **Enter** when the option code is displayed. Use the **#1/ConeFire** key or **#2/AddTime** key to change the setting for the option. Press **Enter** after making the change.

Option List

<i>SPd</i>	Speed	<i>Changes cone program speed by ±40%</i>
<i>OFST</i>	Cone Offset	<i>Adjust firing temperature to match witness cones by ±20°</i>
<i>TCOS</i>	Thermocouple Offset	<i>Change a thermocouple temperature reading by ±25°</i>
<i>FAN</i>	Vent Fan	<i>Set the Vent Fan control for cone programs (if enabled)</i>
<i>CHG -</i>	Change Temperature Units	<i>Change temperature units to °F or °C</i>
<i>TC</i>	Thermocouple Type	<i>Select thermocouple type (Type K, S, R)</i>
<i>AOP</i>	Auxiliary Output	<i>Enable a vent fan or external alarm output</i>
<i>RATE</i>	Ramp Rate units	<i>Change units for programming ramp speed</i>
<i>COST</i>	COST per Kilowatt	<i>Calculate firing cost</i>
<i>KW</i>	Kiln Power Rating	<i>Calculate power consumption Kilowatt hours</i>
<i>Id</i>	Computer ID #	<i>Assign a number from 0 to 15 as a controller ID</i>
<i>TEdE</i>	Temperature Deviation	<i>Deviation setting for alarms FtH, FtC, LtdE and HtdE</i>
<i>bAL</i>	Power Balance	<i>Change power between top and bottom heating zones if option supplied</i>
<i>CAdJ</i>	Centre Power Adjust	<i>Adjust power to middle heating zone, if option supplied</i>
<i>SFTY</i>	Safety Temperature	<i>Displays maximum programmable temperature</i>
<i>TI23</i>	Thermocouple Temperatures	<i>Displays individual thermocouple temperatures if option supplied</i>
<i>ELEC</i>	Electronics Temperature	<i>Displays temperature of the electronics</i>
<i>LOCK</i>	Program Lock	<i>Lock or Unlock the programs against changes</i>
<i>CFG</i>	Configuration Number	<i>Displays factory configuration #</i>
<i>SOFT</i>	Software Version	<i>Displays factory software version</i>
<i>TEST</i>	Test Heating Elements	<i>Test controller inputs and outputs</i>
<i>RST</i>	Factory Reset	<i>Reset all values to factory settings.</i>

The options list will vary depending on the controller configuration. If the program loaded into memory is a User Program, Cone fire options do not appear.

Options Descriptions

Firing Speed - SPd

Speed is a Cone Fire option. Slow settings are for heavy loads and fast settings are for light loads. Speed alters all heating ramps of a Cone Fire program except the final heating ramp and the optional Preheat and the optional Cooling. The Speed option must be modified before the kiln is started.

Three speeds (Fast, Standard and Slow) are available on the front panel for convenience. Fast is the same as the **F 20** setting within the **SPd** option. Slow is the same as the **S 20** setting within the **SPd** option. In addition to Fast and Slow which can be selected from the keypad during Cone Fire programming to change the firing speed by 20%, the **SPd** option allows adjustments in 10% increments up to 40%.

First program the Cone firing and select one of the three speeds, With the controller displaying **IdLE**, press the **#0/Option** key to display **SPd**. Press **Enter** and use the **#1** or **#2** key to change the setting. Press **Enter** again to return to the option menu. **SPd** settings are stored in memory but the setting is over-written when you program a new Cone firing and select a new speed.

Settings

Std

S 10, S 20, S 30, S 40

F 10, F 20, F 30, F 40

Meaning

Standard – See cone-fire tables for standard firing speed

Slow - Slows firing time by 10%, 20%, 30% or 40%

Fast - Accelerates firing time by 10%, 20%, 30% or 40%

Cone Offset - OFST

This offset feature allows you to adjust the final heating step of the Cone programs. This is useful when the kiln does not quite bend witness cones to the desired angle. Cone Offset is a calibration feature that allows a separate temperature offset for the High Fire Programs (cones 1-12), Mid Fire (cones 010-01) and Low Fire (cones 022-011).

First program the Cone firing then press the **#0/Option** key until the display shows **OFST** and press **Enter**. Use the **#1** or **#2** key to change the offset value. Press **Enter** again to return to the option menu. **OFST** settings are stored in memory and will apply to all future Cone fire programs in the same range.

<u>Settings (°F)</u>	<u>Settings (°C)</u>	<u>Meaning</u>
-20	-11	Decreases final ramp temperatures
-15	-8	Decreases final ramp temperatures
-10	-6	Decreases final ramp temperatures
-5	-3	Decreases final ramp temperatures
0	0	No adjustment in temperatures
5	3	Increases final ramp temperatures
10	6	Increases final ramp temperatures
15	8	Increases final ramp temperatures
20	11	Increases final ramp temperatures

Thermocouple Offset - TCOS

This offset adjusts the thermocouple reading on the controller up to $\pm 45^{\circ}\text{F}(25^{\circ}\text{C})$. **TCOS** can be used to compensate for inaccurate temperature readings resulting from aged or poorly positioned thermocouples. Temperature offset applies to all firings.

To Program the offset, Press **#0/Option** key until the display shows **TCOS** and press **Enter**

If you want the kiln to fire Hotter, press **#1/ConeFire** key and the display will show **H-1**. Continue pressing **#1** until the desired thermocouple offset shows in the display (e.g. **H-15** for a 15° offset) and press **Enter**.

If you want the kiln to fire Cooler, press **#2/AddTime** key and the display will show **C-1**. Continue pressing **#2** until the desired thermocouple offset shows in the display (e.g. **C-10** for a 10° offset) and press **Enter**.

Vent Fan - FAN

The Fan Option is used for Cone-fire programs only. The controller must be equipped with an auxiliary output relay and the **AOP** option must be set to **A2F3** or **F2A3**.

<u>Settings</u>	<u>Meaning</u>
OFF	Fan is Off all the time
ON	Fan is On until kiln cools to $212^{\circ}\text{F}(100^{\circ}\text{C})$
OPT	Fan is On until the final ramp. It then turns off for the remainder of the firing.

Note: If the kiln is above 900°C and struggling to reach temperature, the vent fan will turn off automatically for the remainder of the heating cycle.

Temperature Difference - dIFF

The **dIFF** Option displays the largest temperature difference between the top, middle, and bottom thermocouples if option supplied ie multiple thermocouples. This feature is useful in determining temperature uniformity within a kiln during a firing.

Change Temperature Units – CHG-

The **CHG-** Option allows the temperature units to be displayed in either degrees Fahrenheit (°F) or degrees Centigrade (°C).

Thermocouple Type - TC

The **TC** Option allows Type “K”, “S”, or “R” thermocouples. The setting must match the actual thermocouples in use.

<u>Settings</u>	<u>Meaning</u>
K	Type K
S	Type S
R	Type R

Auxiliary Output - AOP

The **AOP** Option sets the Auxiliary relay outputs to the desired functions for controlling a Vent fan and/or External alarm. Setting the **AOP** option to **A2F3** or **F2A3** enables the **FAN** option for cone Fire programs and the **FN** ramp segment for User Programs.

<u>Settings</u>	<u>Meaning</u>
NONE	No external relay functions
F2A3	Vent fan is enabled on output J3 pin 2, Alarm on J3 pin 3
A2F3	Vent fan is enabled on output J3 pin 3, Alarm on J3 pin 2

Ramp Rate Units - RATE

The **RATE** Option sets the units for programming and review of heating and cooling rates. The factory default setting is for Degrees per Hour.

<u>Settings</u>	<u>Meaning</u>	<u>MAX 'FULL' rate</u>
HOOR	Degrees per Hour	999°C (1799°F)/Hour
MIN	Degrees per Minute	16.65°C(29.97°F)/Minute
TIME	Time to Temperature (Hours.Minutes)	00.00 Hours.minutes

Electricity Cost - COST

The **COST** Option allows the operator to set a value for the Kilowatt Hour usage of the electric service. This value is used to calculate a firing cost for review on the controller display. The value must be entered by the user, it can usually be found on your electric bill. Cost calculations first require a second value entry in the **KW** option as described below. Cost calculations are only as accurate as the programmed variables. To view the **COST** calculations, press the #8 key during or after the kiln firing.

Kilowatt rating - KW

The **KW** Option allows the operator to set a value for the Kilowatt rating of the kiln. This value is used to calculate a Kilowatt/Hour usage for review on the controller display. The wattage rating must be entered by the user, it can usually be found on the kiln manufacturer label. **KWHR** calculations are only as accurate as the programmed **KW** value. To view the **KWHR** calculations, press the #8 key during or after the kiln firing

Identification Number - Id

The **Id** Option sets a controller identification number for *Orton ControlMaster* software program. This is an identification number from 0 to 15.

Temperature Deviation - TEde

The **TEde** Option sets a temperature deviation value at which an audible and visual alarm will occur. The temperature deviation applies to the following alarms - **FTH**, **FTC** and **LTde**. The factory setting is 100°F (56°C). The alarms can be disabled by setting the value to zero. Use the numeric keypad to enter the desired deviation value and press **Enter**.

Top/Bottom Balance - bAL

The **bAL** option is only available on controllers that have been configured to operate independent relays for the top and bottom kiln sections. **bAL** changes the amount of power being supplied to the top and bottom heating elements by selecting a power percentage between 0% and 200%. This is the percentage of power going to the top heating elements. Values less than 100 reduce power to the top, while higher values increase power to the top. The Power to the bottom heating element is automatically changed. This feature can be used if the kiln is not heating uniformly.

100% is the factory default. This applies 100% of available power to both the top and bottom elements. Changing the setting to 150% would increase the power to the top elements by 50%, while decreasing power to the bottom elements by 50%. The **bAL** setting can be changed in increments of 10%

Centre Zone Adjustment - CAJ

The **CAJ** option is available on controllers that have been configured to operate an independent relay for the centre kiln section. **CAJ** allows changes in the amount of power supplied to the middle heating elements of the kiln by selecting a power percentage between 0% and 200%. Values less than 100 reduce the power to the centre zone, while values greater than 100 will increase the power. This feature can be used if the kiln is not heating uniformly. 95 is the factory setting. The **CAJ** setting can be changed in increments of 10%

Safety Temperature - SFTY

This option displays the maximum programmable temperature allowed by the controller.

Thermocouple Temperatures – T123

T123 displays the independent temperature readings for controllers where the option has been supplied with the kiln. These are **TC 1** for the top, **TC 2** for the middle and **TC 3** for the bottom thermocouple. During normal operation, the average temperature reading is reported on the display. This option can be used to verify temperature uniformity throughout the kiln. The message [- - -] indicates no temperature reading found.

Electronics Temperature - ELEC

ELEC displays the controller electronics temperature. This can be useful in monitoring the electronics temperature in hot environments or for diagnosing a controller problem. The **ETH** alarm will activate if the controller temperature is above 80°C (176°F)

Program Lock Mode - LOCK

The **LOCK** Option allows either a single User Program or a Cone Fire program to be locked into memory, preventing the settings to be changed from the keypad. This feature is useful when only one particular program is used repeatedly to fire the kiln. When **LOCK** is set to **LO**, only the Delay Start time can be changed. **UN** is the Unlocked setting.

To change between Locked and Unlocked mode, press the **#3/Delay** key three times. Press **Enter** to select either **LO** or **UN** and then press **Stop**

Configuration Number - CFG

CFG displays the factory configuration number. this identifies the controller model.

Software Version - SOFT

SOFT displays the factory software version of the controller.

Test Inputs and Outputs - TEST

Where the option has been supplied with the kiln, the **TEST** Option allows the heating elements for each zone to be turned on independently for 2 minutes while monitoring the thermocouple temperatures for each zone. In sequence, each zone turns on and displays the temperature for the corresponding thermocouple. You can Press **Enter** to advance to the next zone before the 2 minutes expires. **TEST** will also activate the Auxiliary outputs identified as **J3-2** and **J3-3**.

Reset - RST

The **RST** feature clears the controller memory of all existing program values and replaces these with the original factory values supplied with the controller. Do not perform a reset unless all other efforts to correct faults with the controller have failed. A reset may change important option settings for your kiln. Before attempting a reset, you should become familiar with the correct option settings for your controller. Most important is the **TC** option setting.

To reset the controller, press the **#0/Option** key until **RST** is displayed and press **Enter**. Use the **#1** or **#2** key to change the setting from **NO** to **YES** and press **Enter**. This will reset the controller to the factory configuration. Verify the controller is accurately displaying temperature after the reset. You may need to adjust the **TC** setting for the thermocouple and the **CHG-** setting for the display temperature.

	<u>Parameter</u>	<u>Resets to</u>	<u>Possible Action</u>
TC	Thermocouple Type	Type S	Set to Type K
CHG-	Temperature Units:	Fahrenheit (°F)	Set to °C

It will be necessary to re-enter any User Programs that were stored in memory.

Reference Section

Appendix A – Low Fire Cone Programs

Cones O22 to O11

The low fire range is typically used to fire decals or decorations. Some decals, lusters, and gold have a limited firing range and may need to be fired more slowly.

The complete firing schedules for Cones **O22** to **O11** are shown below. The standard firing time is about 3-5 hours.

Degrees F

Low Fire Cone #	Ramp 1 Degrees/hour	Target °F	Ramp 2 Degrees/hour	Target °F
022	396	979	108	1087
021	396	1004	108	1112
020	396	1051	108	1159
019	396	1144	108	1252
018	396	1211	108	1319
017	396	1252	108	1360
016	396	1314	108	1422
015	396	1348	108	1456
014	396	1377	108	1485
013	396	1431	108	1539
012	396	1474	108	1582
011	396	1499	108	1607

Degrees C

Low Fire Cone #	Ramp 1 Degrees/hour	Target °C	Ramp 2 Degrees/hour	Target °C
022	220	526	60	586
021	220	540	60	600
020	220	566	60	626
019	220	618	60	678
018	220	655	60	715
017	220	678	60	738
016	220	712	60	772
015	220	731	60	791
014	220	747	60	807
013	220	777	60	837
012	220	801	60	861
011	220	815	60	875

Appendix B – Mid Fire Cone Programs

Cones O10 to O1

This firing range is used to fire earthenware and low temperature glazes. If the ware is not thoroughly dried, a preheat cycle can be added. With lead-free glazes, a 10 to 20 minute hold is beneficial.

Earthenware or other bodies containing ball clays, talc, and kaolin contain compounds such as water, carbon, and sulfur that are burned-off during the firing. The body will lose about 10% of its weight. In addition, a physical change in any silica present can cause cracking of ware unless the heating rate is slowed near 1063°F (573°C). This change occurs during both heating and cooling.

The complete firing schedules for Cones **O10** to **O1** are shown below. The standard firing time is about 6-8 hours.

Degrees F

Mid Fire Cone #	Ramp 1 Degrees/hour	Target °F	Ramp 2 Degrees/hour	Target °F	Ramp 3 Degrees/hour	Target °F	Ramp 4 Degrees/hour	Target °F
010	324	1022	153	1112	180	1549	108	1657
09	324	1022	153	1112	180	1580	108	1688
08	324	1022	153	1112	180	1620	108	1728
07	324	1022	153	1112	180	1681	108	1789
06	324	1022	153	1112	180	1720	108	1828
05	324	1022	153	1112	180	1780	108	1888
04	324	1022	153	1112	180	1837	108	1945
03	324	1022	153	1112	180	1879	108	1987
02	324	1022	153	1112	180	1908	108	2016
01	324	1022	153	1112	180	1938	108	2046

Degrees C

Mid Fire Cone #	Ramp 1 Degrees/hour	Target °C	Ramp 2 Degrees/hour	Target °C	Ramp 3 Degrees/hour	Target °C	Ramp 4 Degrees/hour	Target °C
010	180	550	85	600	100	843	60	903
09	180	550	85	600	100	860	60	920
08	180	550	85	600	100	882	60	942
07	180	550	85	600	100	916	60	976
06	180	550	85	600	100	938	60	998
05	180	550	85	600	100	971	60	1031
04	180	550	85	600	100	1003	60	1063
03	180	550	85	600	100	1026	60	1086
02	180	550	85	600	100	1042	60	1102
01	180	550	85	600	100	1059	60	1119

Appendix C – High Fire Cone Programs

Cones 1 to 12

The firing range of higher temperature bodies, such as stoneware and porcelain varies between Cone 4 and Cone 10. These bodies are fired nearly to vitrification and can shrink up to 16%. As with earthenware bodies, water, carbon, and sulfur are potential burnout materials and venting is important to remove gases generated. With the presence of silica, the firing needs to be slowed near 1063°F (573°C) to prevent cracking.

Typical porcelain bodies are formulated from kaolin, feldspars, silica, and ball clays. The weight loss during firing can be around 10 to 12% and shrinkage can approach 20%.

Porcelain bodies require good temperature uniformity at their final firing temperature. If slightly overfired, the body may warp or blister. On maturing, the body becomes its own “glaze.” A hold time is usually desirable for best fired results.

The complete firing schedules for Cones 1 to 12 are shown below. The standard firing time is about 9-11 hours.

Degrees F

Hi Fire	Ramp 1	Target	Ramp 2	Target	Ramp 3	Target	Ramp 4	Target
Cone #	Degrees/ hour	°F	Degrees/ hour	°F	Degrees/ hour	°F	Degrees/ hour	°F
1	324	1022	153	1112	162	1863	108	2079
2	324	1022	153	1112	162	1872	108	2088
3	324	1022	153	1112	162	1890	108	2106
4	324	1022	153	1112	162	1908	108	2124
5	324	1022	153	1112	162	1951	108	2167
6	324	1022	153	1112	162	2016	108	2232
7	324	1022	153	1112	162	2046	108	2262
8	324	1022	153	1112	162	2064	108	2280
9	324	1022	153	1112	162	2084	108	2300
10	324	1022	153	1112	162	2129	108	2345
11	324	1022	153	1112	162	2145	108	2361
12	324	1022	153	1112	162	2167	108	2383

Degrees C

Hi Fire	Ramp 1	Target	Ramp 2	Target	Ramp 3	Target	Ramp 4	Target
Cone #	Degrees/ hour	°C	Degrees/ hour	°C	Degrees/ hour	°C	Degrees/ hour	°C
1	180	550	100	600	90	1017	60	1137
2	180	550	100	600	90	1022	60	1142
3	180	550	100	600	90	1032	60	1152
4	180	550	100	600	90	1042	60	1162
5	180	550	100	600	90	1066	60	1186
6	180	550	100	600	90	1102	60	1222
7	180	550	100	600	90	1119	60	1239
8	180	550	100	600	90	1129	60	1249
9	180	550	100	600	90	1140	60	1260
10	180	550	100	600	90	1165	60	1285
11	180	550	100	600	90	1174	60	1294
12	180	550	100	600	90	1186	60	1306

Appendix D – User Program Charts

User Program # 1

Ramp #	Rate: °/hr	Temperature	Hold Time	Vent Fan: on/off
1				
2				
3				
4				
5				
6				
7				
8				
9				
10				
11				
12				
13				
14				
15				
16				
17				
18				
19				
20				

User Program # 2

Ramp #	Rate: °/hr	Temperature	Hold Time	Vent Fan: on/off
1				
2				
3				
4				
5				
6				
7				
8				
9				
10				

User Program # 3

Ramp #	Rate: °/hr	Temperature	Hold Time	Vent Fan: on/off
1				
2				
3				
4				
5				
6				
7				
8				
9				
10				

User Program # 4

Ramp #	Rate: °/hr	Temperature	Hold Time	Vent Fan: on/off
1				
2				
3				
4				
5				
6				
7				
8				
9				
10				

Appendix E – Connecting Thermocouples

Type K Thermocouples shown. For Type S or Type R thermocouples, the positive (+) leg of the thermocouple should be color coded Black.

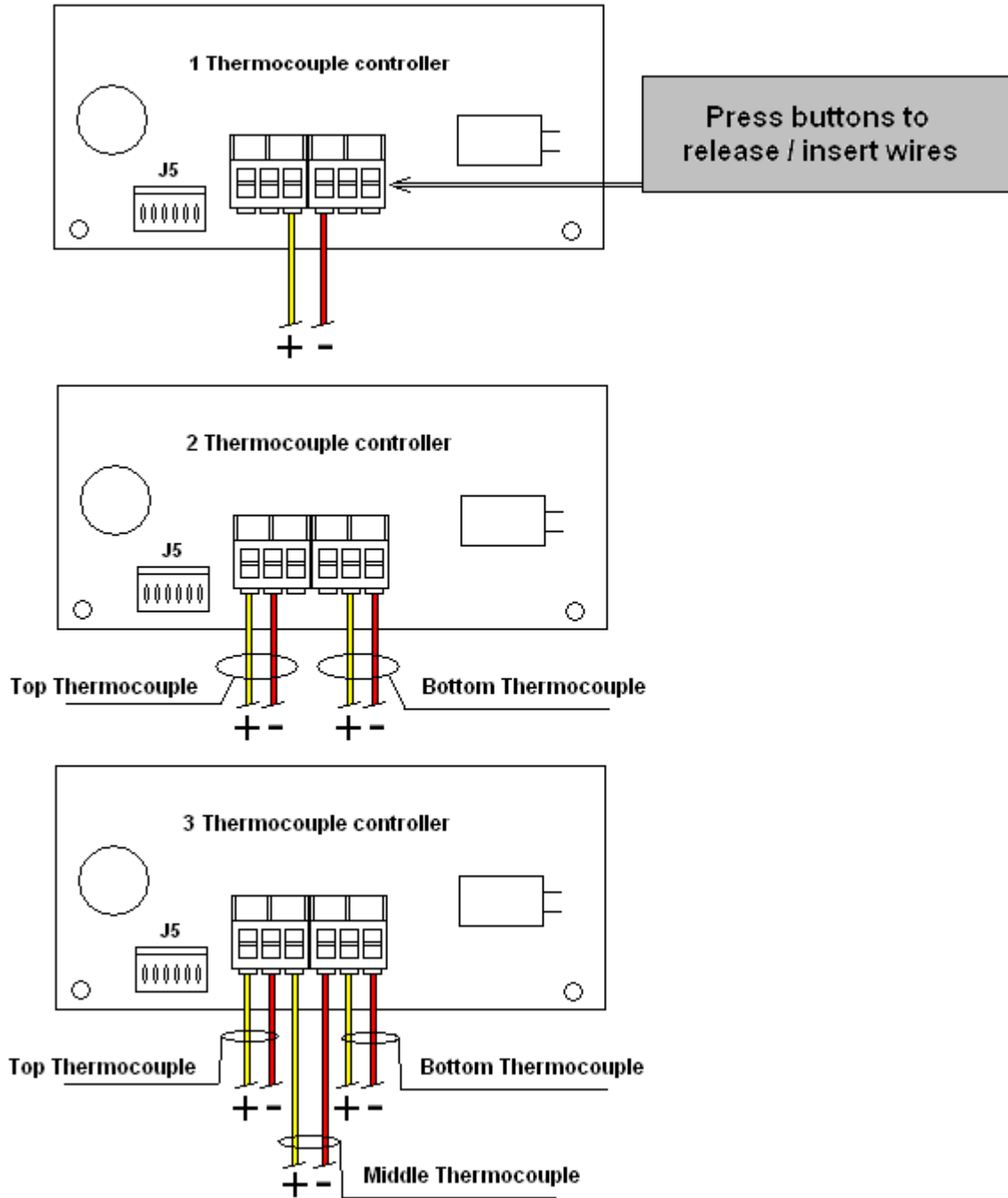

Appendix F – Typical Wiring Diagram

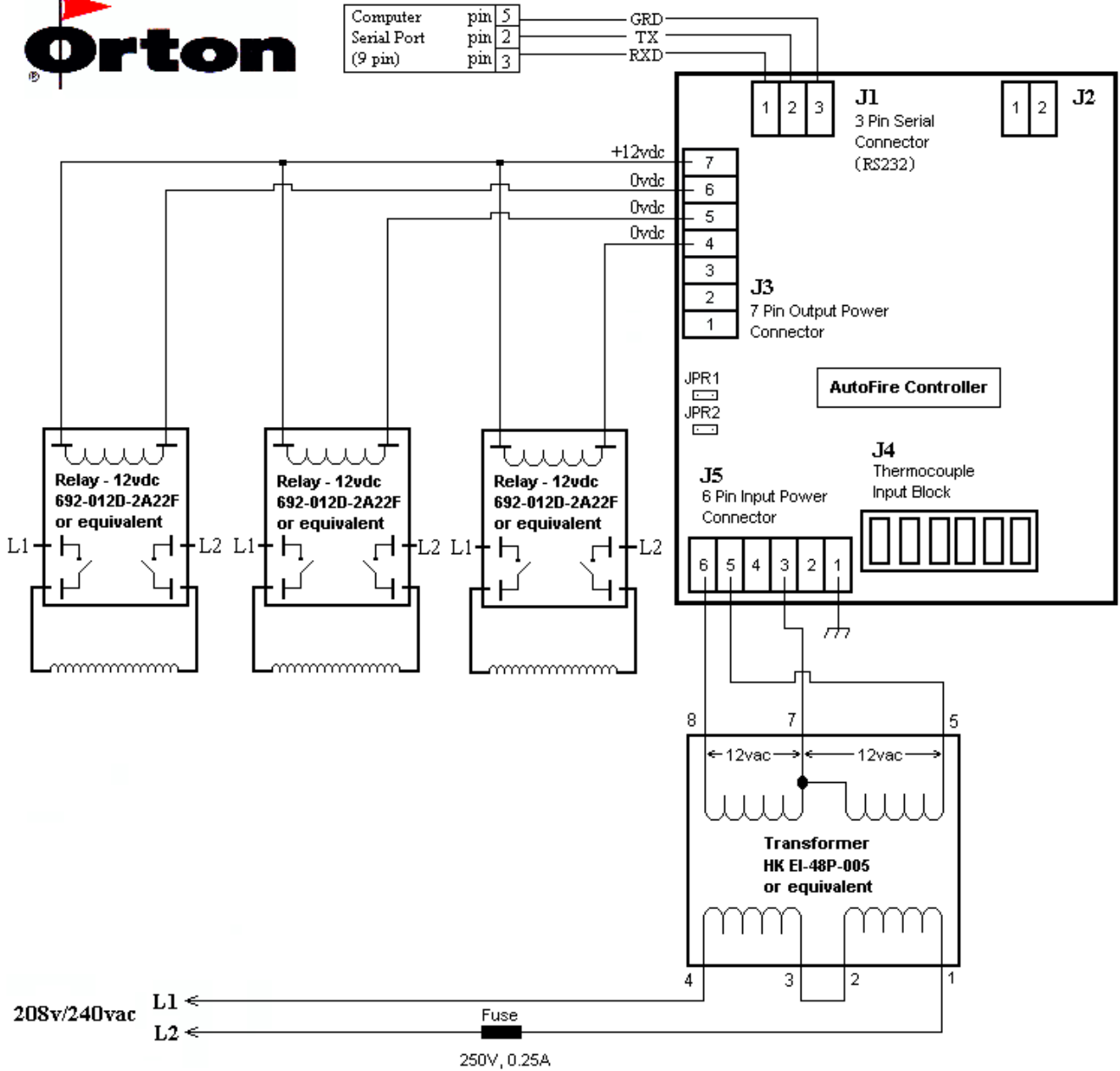

Firemaster 6[®] Kiln Controller

Limited Warranty from Orton

This limited warranty is given only to the immediate purchaser ("Buyer") of the Firemaster 6[®] Kiln Controller ("ZM01"). This limited warranty is not transferable. The Edward Orton Jr. Ceramic Foundation ("Orton") warrants the controller motherboard and keypad installed on the Firemaster 6[®] Kiln Controller ("Warranted Components") to be in good working order under normal operating conditions for a period of two (2) year from the date of purchase. Should the Warranted Components fail to be in good working order at any time during the stated two (2) year period, Orton will, at its option, repair or replace the Warranted Components as set forth below. The liability of Orton is limited to replacement and/or repair at its factory of the Warranted Components that does not remain in good working order. Repair parts or replacement products will be furnished on an exchange basis and will be either reconditioned or new. All replaced parts or products become the property of Orton. Following receipt of notice from Buyer of a valid warranty claim and the Firemaster 6[®] Kiln Controller containing the Warranted Components, Orton will perform its obligations under this limited warranty within 10 business days.

Limited warranty service may be obtained by delivering the Firemaster 6[®] Kiln Controller during the warranty period to your Potclays/Orton Firemaster 6[®] Supplier or to The Edward Orton Jr. Ceramic Foundation, 6991 Old 3C Highway, Westerville, Ohio 43082 and providing written proof of purchase and a description of the defect or problem. Buyer must insure the shipment of the Firemaster 6[®] Kiln Controller or assume the risk of loss or damage in transit, prepay shipping charges to the service location, and use the original shipping container or equivalent. Buyer will be responsible for shipping and handling charges in excess of US \$50.00 incurred by Orton in returning the Firemaster 6[®] Kiln Controller to the Buyer after completion of limited warranty service.

This warranty does not apply to any damage to the Firemaster 6[®] Kiln Controller resulting from:

1. Operation beyond electrical rating.
2. External sources including, but not limited to, chemicals, heat abuse and improper care.
3. Improper or inadequate maintenance by Buyer.
4. Parts or equipment not supplied by Orton.
5. Unauthorized modification or misuse.
6. Operation outside environmental specifications.
7. Improper installation.
8. Over firing (melting of materials being fired) regardless of the cause of the over firing.

Warranted Components returned for service where no warranted defect is found will be subject to service, and shipping and handling fees.

If the Warranted Components are not in good working order as warranted above, Buyer's sole remedy shall be repair or replacement of the Warranted Components as provided above. To the extent permitted by law, ALL EXPRESS AND IMPLIED WARRANTIES FOR THE WARRANTED COMPONENTS INCLUDING THE WARRANTIES OF MERCHANTABILITY AND FITNESS FOR A PARTICULAR PURPOSE ARE LIMITED TO THE TWO YEAR WARRANTY PERIOD COMMENCING ON THE DATE OF PURCHASE, AND NO OTHER WARRANTY WHETHER EXPRESS OR IMPLIED WILL APPLY TO THIS PERIOD. To the extent permitted by law, ORTON'S REMEDY AND BUYER'S SOLE REMEDY IS LIMITED SOLELY AND EXCLUSIVELY TO REPAIR OR REPLACEMENT AS SET FORTH HEREIN. ORTON SHALL NOT BE LIABLE FOR, AND BUYER'S REMEDY SHALL NOT INCLUDE ANY INCIDENTAL, CONSEQUENTIAL OR OTHER DAMAGES OF ANY KIND WHATSOEVER, WHETHER A CLAIM IS BASED UPON THEORY OF CONTRACT, NEGLIGENCE OR TORT. Buyer shall determine suitability of the Firemaster 6[®] Kiln Controller for the intended use and assume all risk and liability therewith. Some states do not allow this exclusion or limitation of incidental or consequential damages, so the above limitation or exclusion may not apply to you. This warranty gives you specific legal rights, and you may also have other rights which vary from State to State.

The above limitation does not apply in the event that any Warranted Components are determined by a court of competent jurisdiction to be defective and to have directly caused bodily injury, death or property damage; provided that in no event shall Orton's liability exceed the greater of \$1,000.00 or the purchase price of the specific Firemaster 6[®] Kiln Controller that caused such damage.

Service may also be obtained on Warranted Components no longer under warranty by returning the Firemaster 6[®] Kiln Controller prepaid to Potclays or Orton with a description of the problem and Buyer's name and contact information. Buyer will be contacted with an estimate of services charges before any work is performed.

Customer Satisfaction Policy

If for any reason you are not completely satisfied with the performance of the Potclays/Orton Firemaster 6[®] Kiln Controller or the conditions of this warranty, return the Firemaster 6[®] Kiln Controller in good working condition, transportation and insurance prepaid, within 30 days of purchase date to your Potclays/Orton Firemaster 6[®] Kiln Controller supplier or The Edward Orton Jr. Ceramic Foundation, 6991 Old 3C Highway, Westerville, Ohio 43082 and your purchase price will be refunded. Prior to returning your Firemaster 6[®] Kiln Controller contact Potclays or Orton for an authorization number and include with your shipment. For Firemaster 6[®] Kiln Controllers ordered in error, a restocking charge will apply.

Potclays Firemaster 6® Kiln Controller

